

Air Transportation Information Exchange - Conference

The need for Global Information Management

Paul Bosman

SWIM/Enterprise Architecture Unit manager, Agency AIM focal point

EUROCONTROL



Today's agenda

Information
Management

*XMs

International
Cooperation

More models

AIS-AIM-SWIM

The need for sharing ATM information

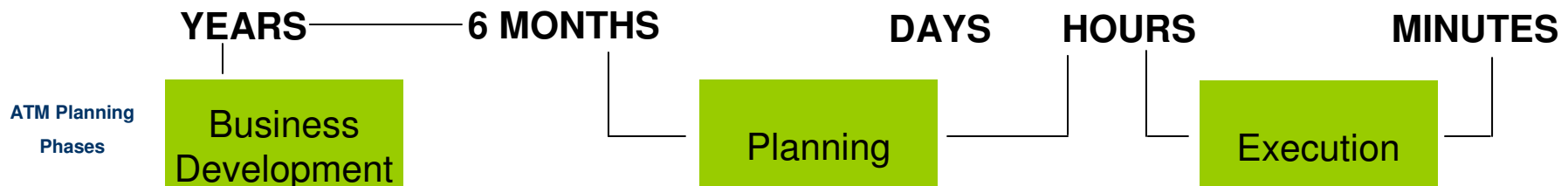

Sharing Information
a Key enabler for
planning – executing - analysis

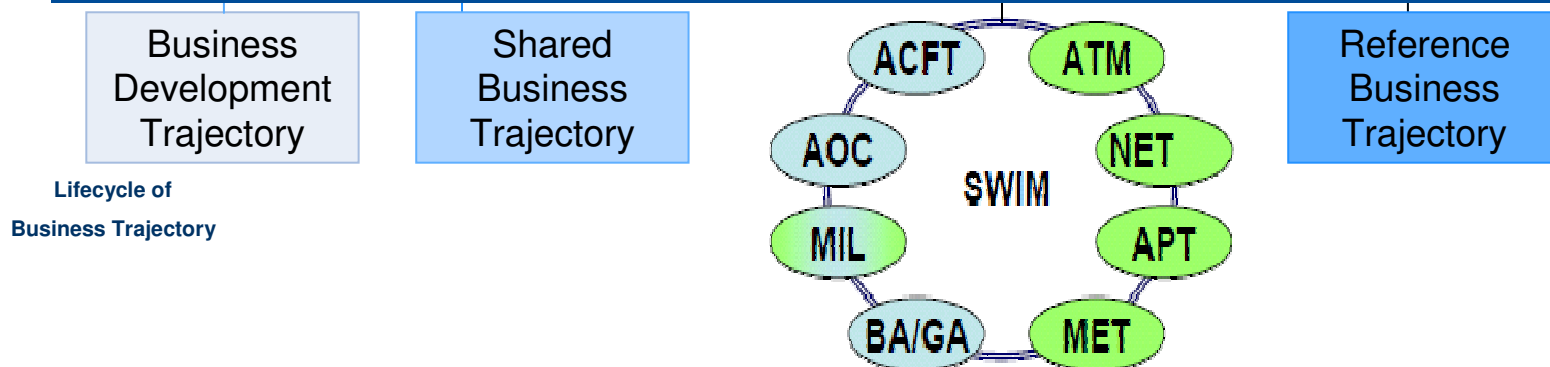



Aeronautical Information Exchange Model (AIXM)

Started in 1997 (!)

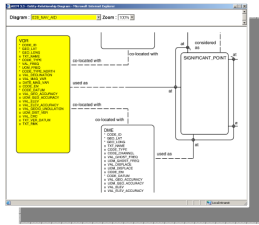

Developed as EAD Data/Db structure

Since 2003 by joint FAA/Eurocontrol



And the rest of the international community

(+- 1000 members, +- 350 organisations) Forum | **AIXM** |



European AIXM implementation through EAD

40 States migrated to EAD

27 States fully Migrated: Static, Dynamic and AIP

13 States partially migrated: Static and/or Dynamic and/or AIP

3 States committed

	Operations.
Greece →	2012
Switzerland →	2012
Ukraine →	2011

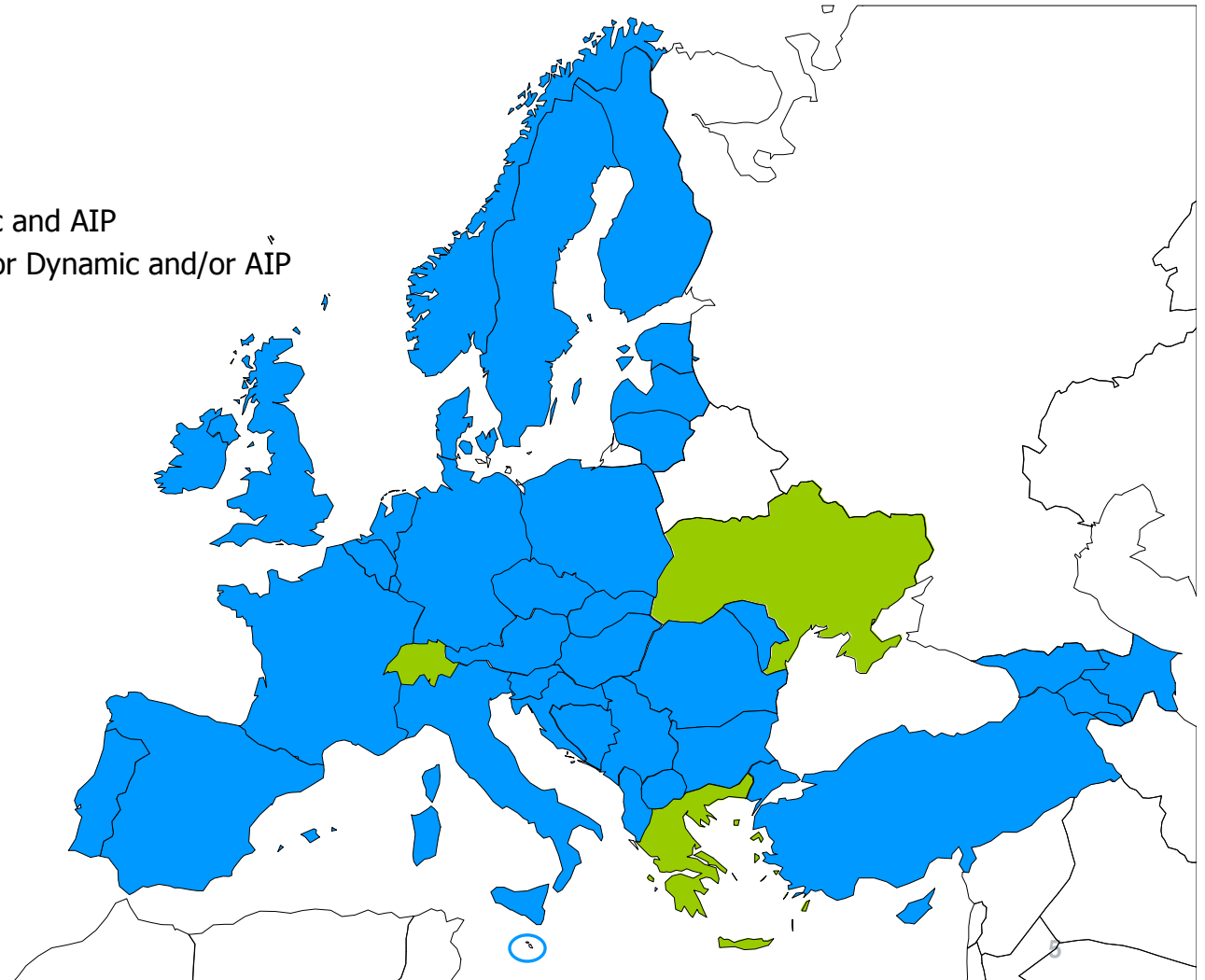

A dream ...

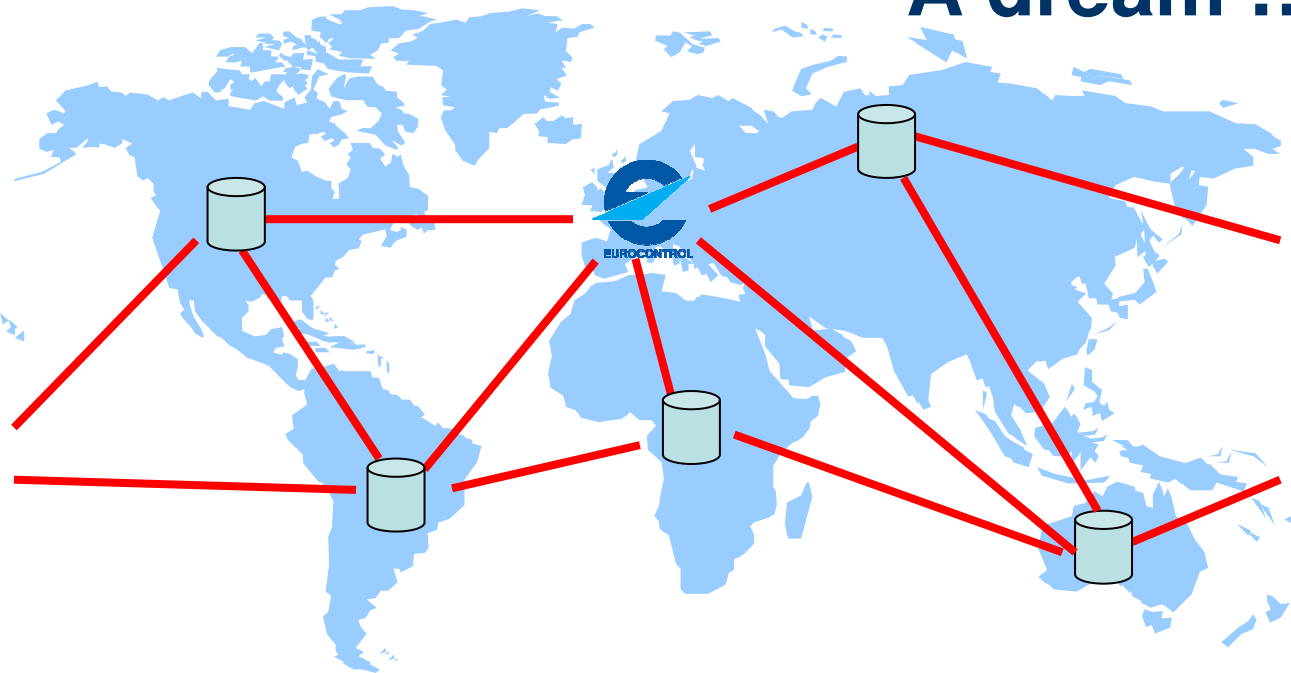

... becoming reality ...

Connected

Canada, Australia, New Zealand, Jordan, Philippines

Committed/testing

Belarus, Egypt, Japan, Kazakhstan, Morocco, Singapore, South Africa, Syria, Taiwan

Discussing

Tunisia, Algeria, FAA, NGA, ...

Developments

Brazil, Russia, India, South-Korea, ...



Weather Exchange Model

- History
 - First steps by EUROCONTROL in 2007
 -  Since 2008 a conjoint FAA/EUROCONTROL development
 - Version 1.1 : mid-2010
- Core of NextGen Weather & SESAR MET Information Exchange
- Coordinated with World Meteorological Organization, ICAO & OGC
- Validated:
 - OGC (OWS 6, 7 and 8)
 - WMO/ICAO (especially in context of exchange via ICAO AFS)
 - NextGen and SESAR demonstrations/validations
 - Industry partners and providers
- Version 2.0 under development
- Reference implementations planned for 2012 (Ash, WX Radar)

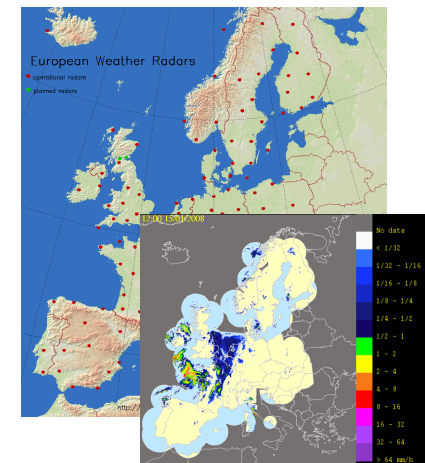
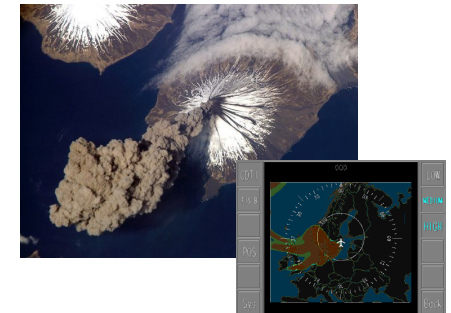
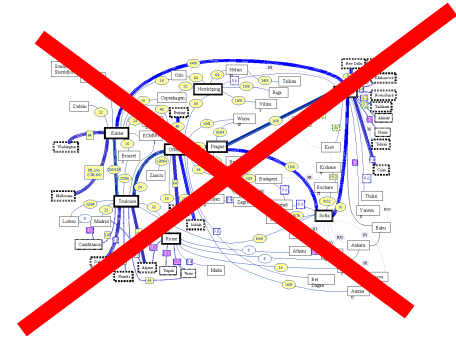

Flight Information Exchange Model

- 2011 initiative
- A data interchange format for sharing information about flights throughout their lifecycle

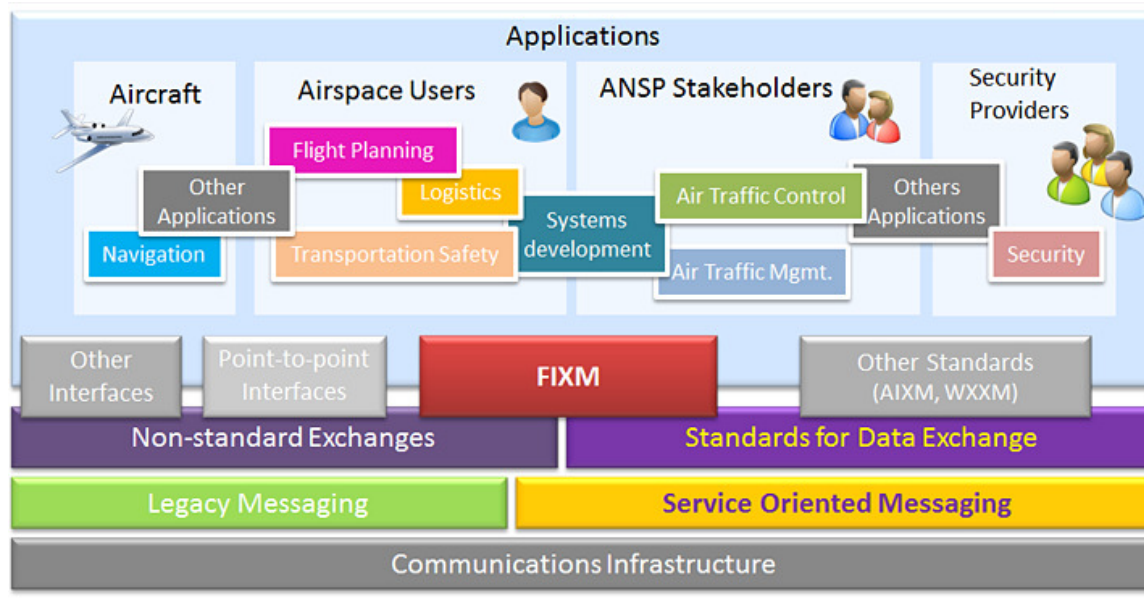

Transition to AIM - The AIS perspective

Data Domain

- AIS transformed to AIM
- AIM = Digital AIS

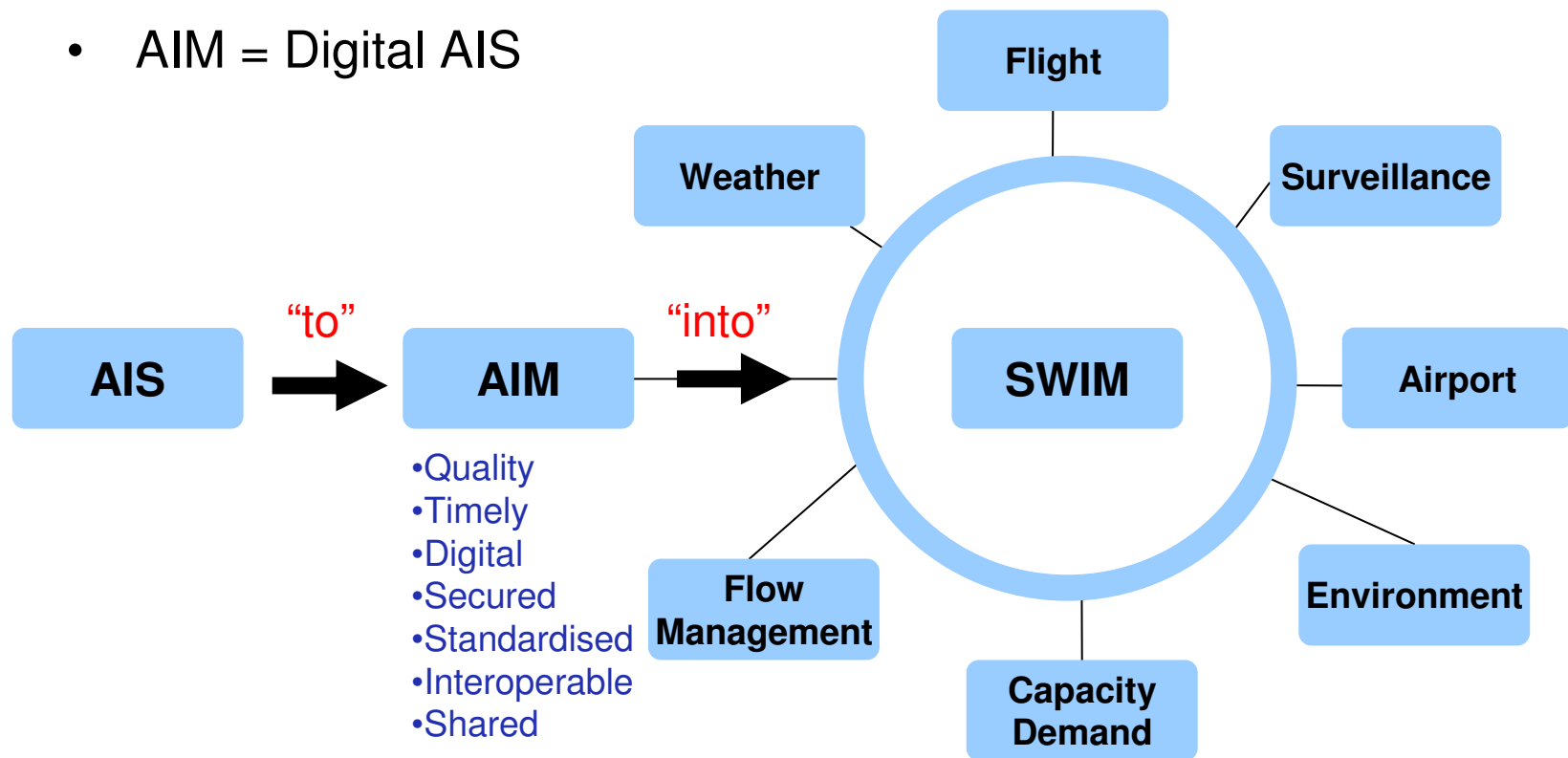

Transition to SWIM – The AIM perspective

- AIM plugged into SWIM system
- SWIM embeds Digital AIM concepts
 - Example: temporality

Data Domain

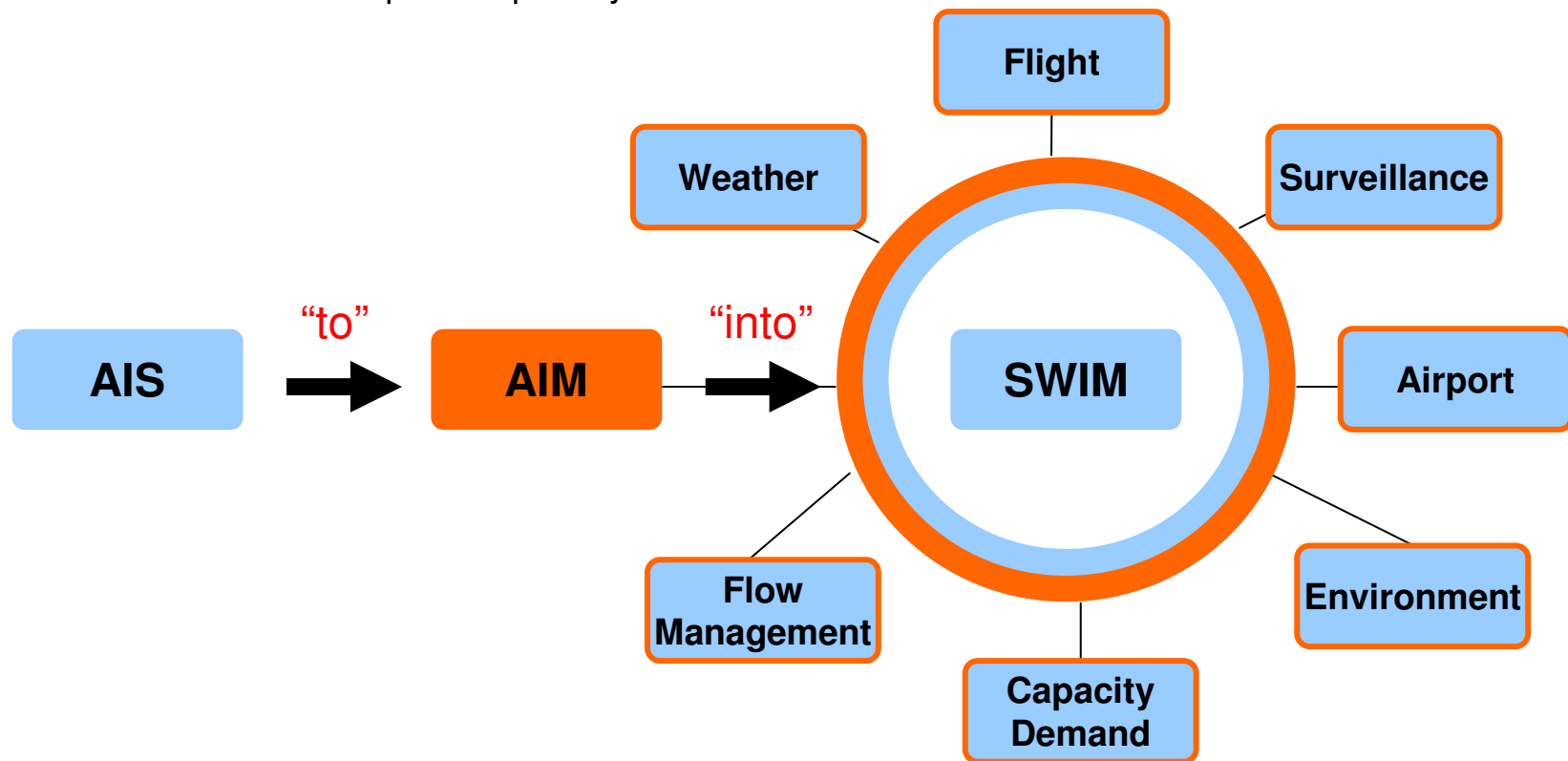

SWIM – Serving the ATM world

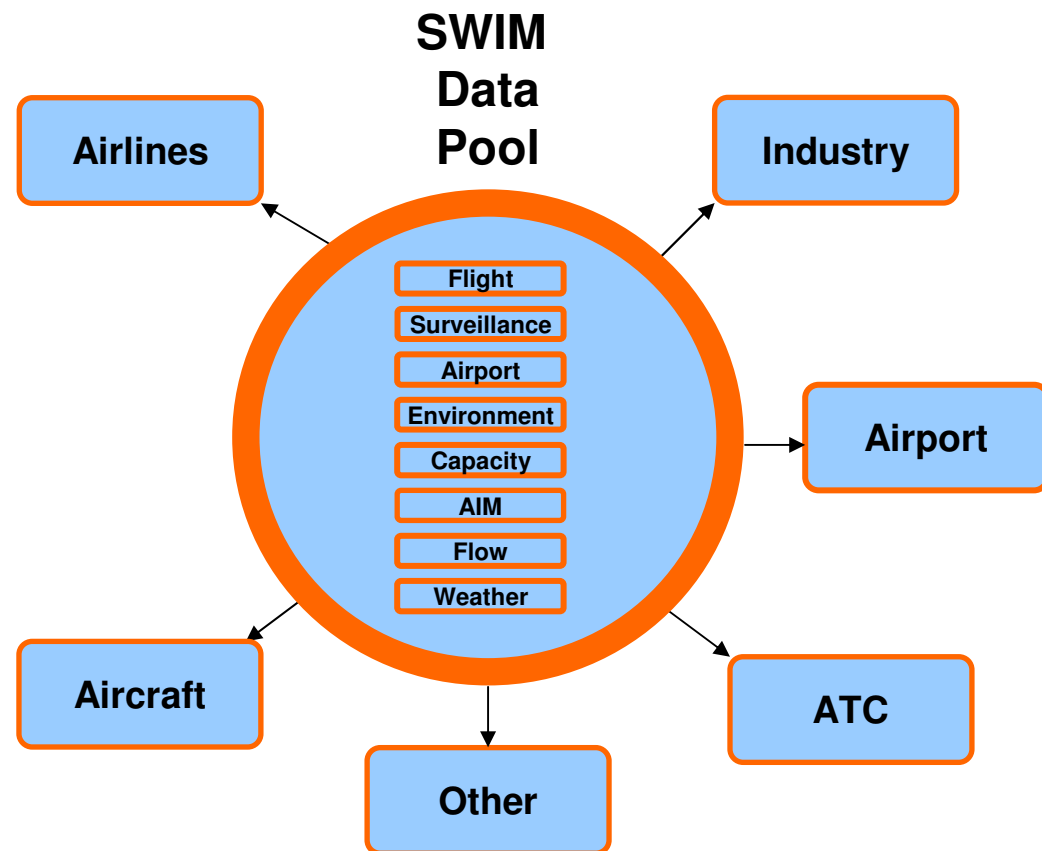

Time for a top-down approach

FAA NAS Architecture

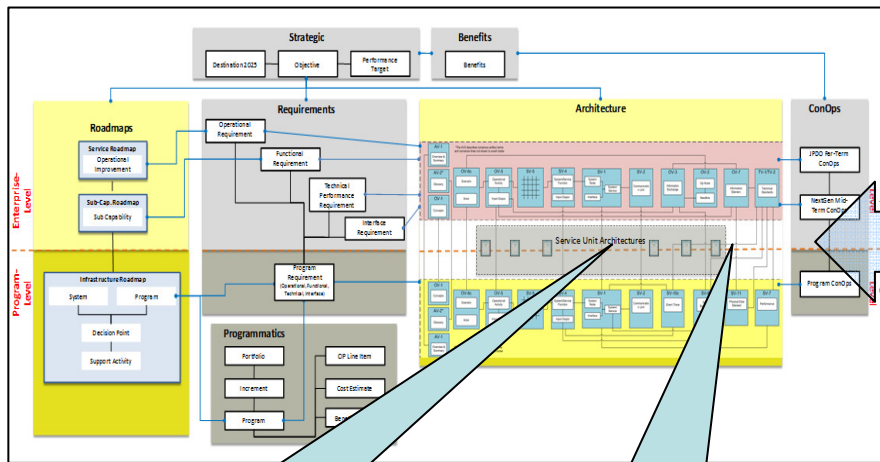

Draft SESAR Architecture

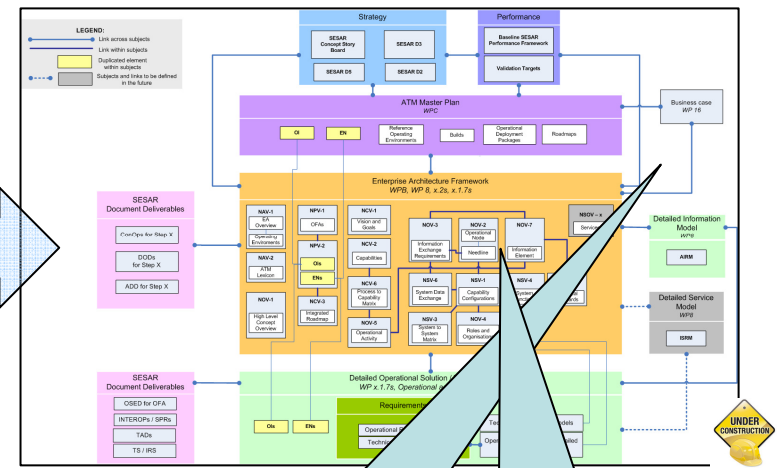

Logical data model (OV-7)

AIRM (NOV-7/ NSV11a)

“Service Approach”



“Service Approach” (ISRM/NSOVxx)

ATM Information Reference Model (AIRM)

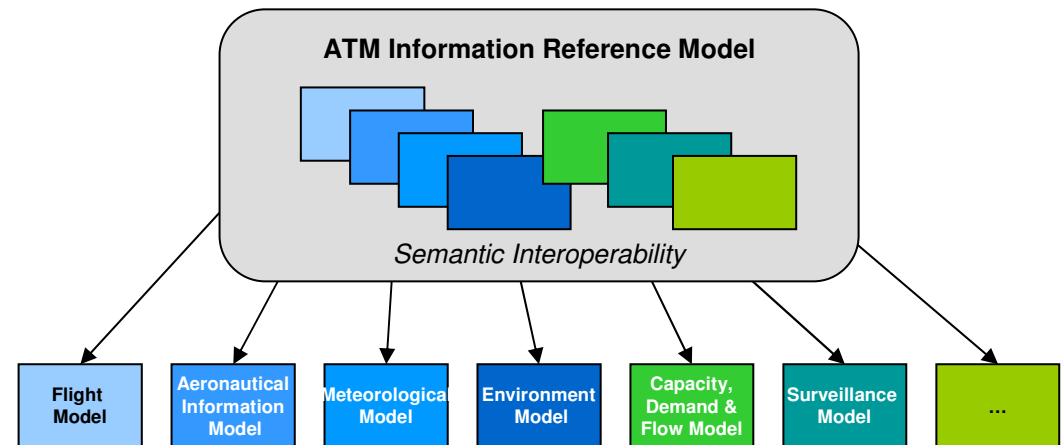

- Ensure **semantic interoperability** within ATM
- Act as a tool for promoting **ATM information standards worldwide**
- Represents **civil & military** ATM information
- Ensure **same shared meaning** of data at both origin and destination
- First version exists, **AIXM/WXXM part of initial load.**

• *“Now, no-one to my knowledge has ever accused AIRM of being “sexy” but it is crucial. It’s vital for global interoperability...”* DG EUROCONTROL

Information Service Reference Model (ISRM)

- Models information to be exchanged by ATM systems (nodes)
- Defines interface and interactions at logical level
- Derives service payloads from AIRM
- Fully SOA based (using NAF Service Oriented views)

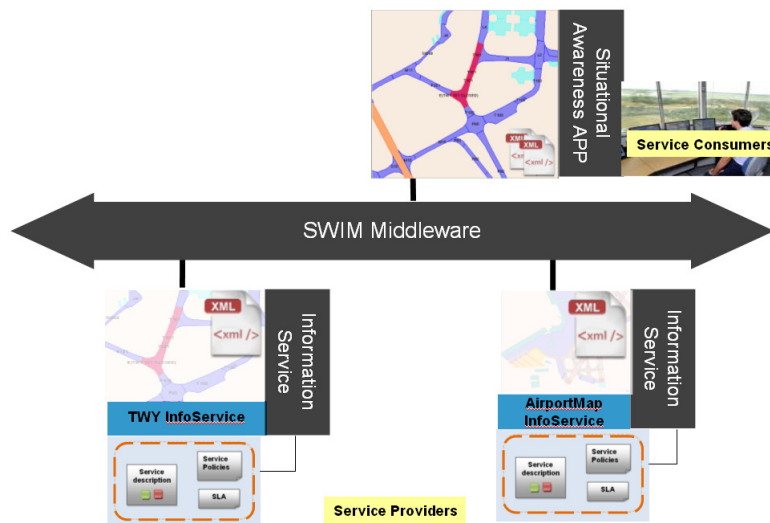
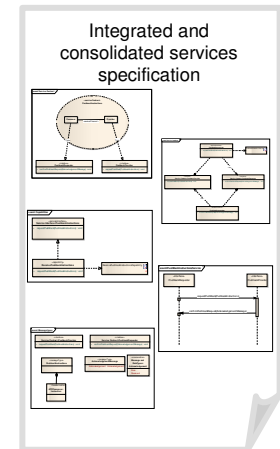

E.g. “**Common Situational Awareness**”

SWIM enabled Application consuming **TWY Status** & **Airport Map Info Services**

Information Management is (so much) more than just Data models ... but first

Information management. [ICAO Annex 15 – draft Amdt 37]

The management of resources and processes for the timely collection, integration, exchange and delivery of quality-assured data, information and services.

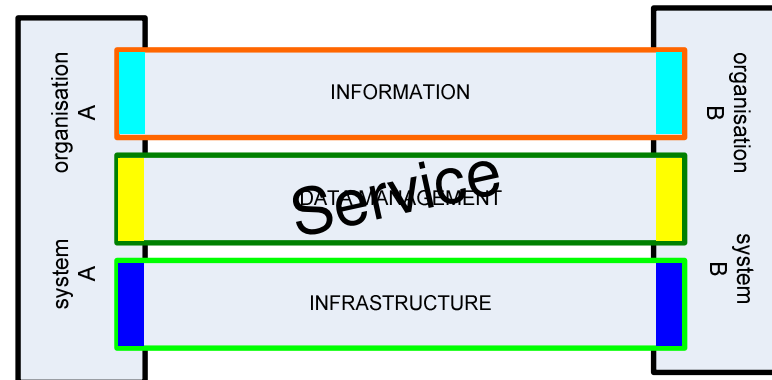
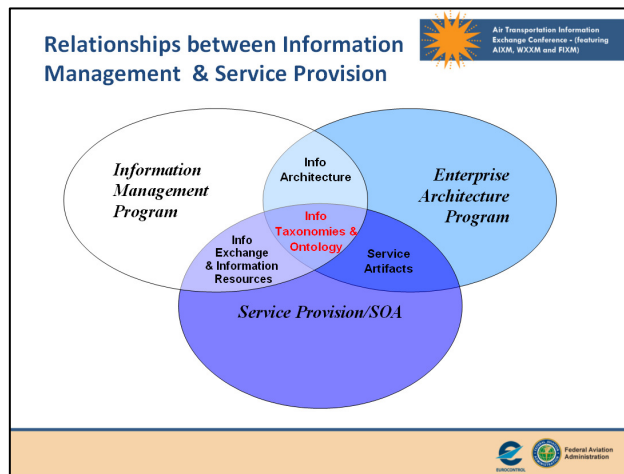

(SW)IM = The ATM implementation of IM

International Coordination – Just some thoughts

- **Global semantic interoperability is key. All to participate !!**
- ICAO *of course but to which level of detail ?*
- The AIXM experience
 - Seeking widest possible stakeholder involvement, further formalised and made transparent through Internet forum & CCB
 - Global adoption through ICAO referencing
 - Regional/national legislation when required
 - *Ok for all ? To be further exploited for ATM SWIM ?*
- OGC – Open Geospatial Consortium
 - Aviation Domain Working Group, Testbeds, ...
 - Usage of standards
 - *How to further evolve ?*
- Registry
 - *Any experiences ? Any global dimension ?*
- SWIM Infrastructure
 - *Time for more international exchanges and trials ?*



Conclusions



- IM, AIRM, ISRM, Registry, ...
 - New terms for ATM
 - Very natural in an Enterprise Architecture (EA) / Service Orientated Architecture (SOA) approach
 - Any similar experiences/activities ?
- Get involved
 - Participate to definitions, data & service models definition & review
 - Contribute to IM Governance discussions - Operational/Technical/Institutional/Organisational/...
- Lets go for a truly global ATM ..
- More information ?
 - <http://www.eurocontrol.int/aim> & <http://www.sesarsju.eu/swim>
 - paul.bosman@eurocontrol.int



This image can only be used for ATS AGORA Promotion. The reproduction of the individual logos and their use requires the permission of the respective owner.